

✂ Frying Performance of Palm Oil Liquid Fractions¹

U. BRACCO, A. DIEFFENBACHER and L. KOLAROVIC, Nestlé Products
 Technical Assistance Co., Ltd., Research Dept., PO Box 88,
 CH-1814 La Tour de Peilz, Switzerland

ABSTRACT

Palm oil liquid fractions were used as frying media in household and industrial fryers and were compared to standard edible oils and fats, such as soybean, groundnut, sunflower, rapeseed and tallow. The analytical evaluation covered free fatty acids, viscosity, smoke and flame points, oxidized fatty acids, nonelution material (NEM), UV differential spectra, polymers and foam index. These values measure the extent of the oil degradation, i.e., oxidation, hydrolysis, splitting and polymerization. Moreover, they were combined with other analytical procedures (fatty acid composition, keeping qualities such as the time necessary for an oxygen-absorbing sample to reach a -0.5 psi pressure in a closed system) in order to have a large analytical control during the frying processes. The data collected show the suitability of edible oils and fats for frying purposes and indicate that palm oil liquid fractions perform satisfactorily as frying media. They have low degradation and produce fried foods with acceptable keeping qualities.

INTRODUCTION

Deep frying fats are widely used in food technology: they prevent sticking, transfer heat from the hot surface to the food and, because they are absorbed on fried foods, they should be considered an important part of the diet.

During the frying process, various chemical reactions occur, such as, oxidation, hydrolysis, polymerization and cracking. Fats decompose to form volatile, monomeric and polymeric compounds.

Chemical and physicochemical characteristics of the oils are thus affected. This thermal degradation should be controlled, not only for technological reasons, but also for safety and nutrition. We adopted a range of analytical methods to judge the suitability of oils as deep frying media and applied them to semi-industrial and industrial processes: data collected indicate that palm oil liquid fractions (POLF) perform satisfactorily in frying operations, show low degradation and produce fried foods with acceptable keeping qualities.

¹Presented at the ISF/AOCS World Congress, New York, April 1980.

EXPERIMENTAL

Frying Processes

In pilot plant trials, POLF and peanut oil are heated in a household fryer, Menafrit 300 L, with a heating capacity of 3,000 W and a total oil capacity of 3,000 ml, equipped with a thermostat to regulate temperature at 180 C (± 10 C).

The surface of the oil vol exposed to air was 418.2 cm² and the specific surface 0.15 cm²/g; specific surface is one of the most important parameters in the stability of oils during frying. In fact, the overall degradation is an oxidation process more than an interaction with frying goods.

Furthermore, according to Pardun's findings (1,2), the frying stability—expressed as time in hr required for heating an oil at 180 C to reach 1% oxidized fatty acids (on total fat)—is proportional to the inverse of the specific surface as defined.

In our trials, the specific surface finally increases to 0.25 cm²/g because of continuous sampling for the analytical checks. It is therefore necessary to correct the analytical

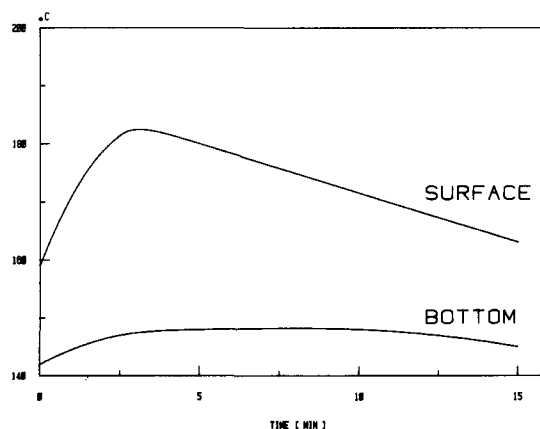

FIG. 1. Temperature changes during thermostatic heating of fryer.

TABLE I

Pilot Plant Trials: Oil Intake vs Heating Time

Frying hours	Oil	Wt of fried food (g)	Wt of oil intake (g)	Total oil intake (g)	Oil intake (%), mean value
0	POLF	4 ^a × 125 ^b	95.5	170.4	15.5
		4 × 150	74.9		
	Peanut	4 × 125	90	172.2	15.65
50	POLF	4 × 150	82.2	175.7	16
		4 × 125	93.7		
	Peanut	4 × 150	82	200	18.2
100	POLF	4 × 125	104.5	180.1	16.4
		4 × 150	95.5		
	Peanut	4 × 125	93.1	219	19.9
		4 × 150	128.6		
		4 × 150	90.4		

^aNumber of frying trials.

^bWeight (g) of each trial.

Total oil weight : 2500 lt
 Oil surface : 16 m²
 Oil circulating : 160 m³/hour
 Speedy : 160 m³/hour

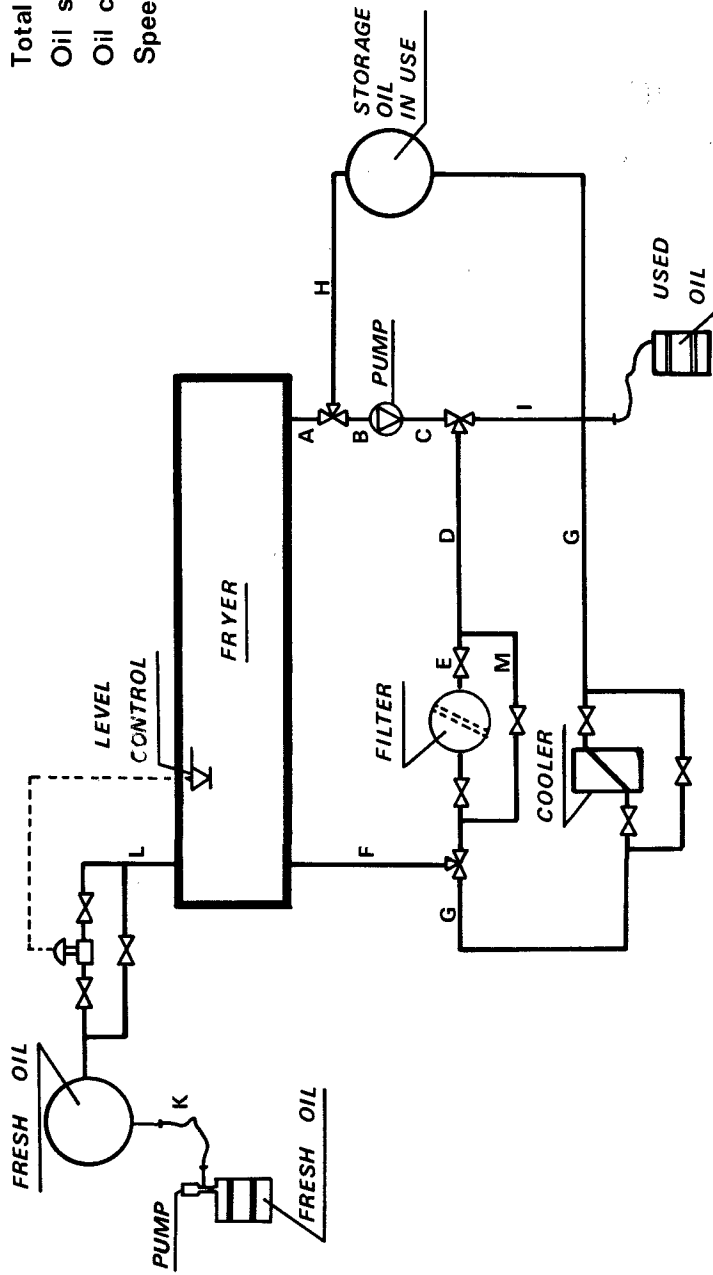

FIG. 2. Schematic diagram of industrial fryer.

figures in order to include in our evaluation the increase of the specific surface. For example, the time correction Δt applied after the third sampling is:

$$\Delta t = \Delta t_1 \cdot 1000 + \Delta t_2 \cdot 1.052 + \Delta t_3 \cdot 1.111$$

1st interval (0-24 hr)	2nd interval (25-48 hr)	3rd interval (49-72 hr)
---------------------------	----------------------------	----------------------------

In a further trial series, we kept the oil vol constant by using 5,000 g frying oil: 3,000 g includes the vol of the fryer and 2,000 g compensates the oil loss due to frying and sampling.

The Menafrit fryer is placed on the Mettler balance to measure oil intake and water loss (at ± 0.1 g), both due to frying. Frying (3,000 g) oil is heated to ~ 180 C. The thermostated fryer operates in ca. 17 min temperature cycles (Fig. 1), in which the heat-up time period was ~ 110 sec.

The frying procedures are done after 0, 50 and 100 hr of continuous heating. A decrease (8-11%) in the weight of fried products is obtained within 15-20 sec at a frying temperature in the range of 160-180 C. Simultaneously, the vol of the fried products (potato slices) doubles. The weight of oil in the fryer is readjusted after each frying procedure (Table I) and sampling (150-g oil samples collected after 50 and 100 hr).

In industrial scale operations, only POLF was used. The frying temperature was fixed at $180 \text{ C} \pm 5 \text{ C}$ on a frying system, EROFA. Total oil vol (fryer, pipeline, filter, heat exchanger) was 2500 l with an oil surface of ca. 16 m^2 . Oil circulated at a speed of $160 \text{ m}^3/\text{hr}$. The frying oil was partially pumped through a filter which has a capacity of $20 \text{ m}^3/\text{hr}$ (Fig. 2). In all experiments, including the industrial scale, we used starchy foods for frying.

Analytical Evaluation

In pilot plant trials, oil samples were analyzed for chemical changes during frying, e.g., oxidation, hydrolytic splitting and polymerization. Evaluation was done according to the

following analyses: free fatty acids (FFA) (3); viscosity (3); smoke and flame point (4); oxidized fatty acids (5); fatty acid composition (6). Evaluation also was made by more specific analytical procedures providing data about (a) noneluted material (NEM) level (by gas liquid chromatography [GLC]) estimating the extent of thermooxidative degradation in terms of unesterifiable and nonelutable structures (7); (b) polymers, determined as the insoluble part of an oil or fat at room temperature after methylation in $\text{MeOH}/\text{H}_2\text{SO}_4$ (8); (c) oxygen absorption, measured as

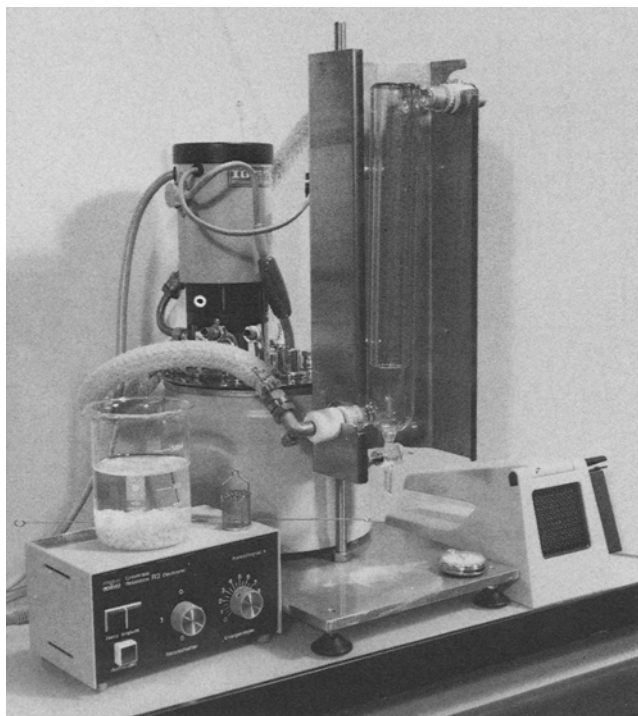

FIG. 3. Foam test analytical equipment.

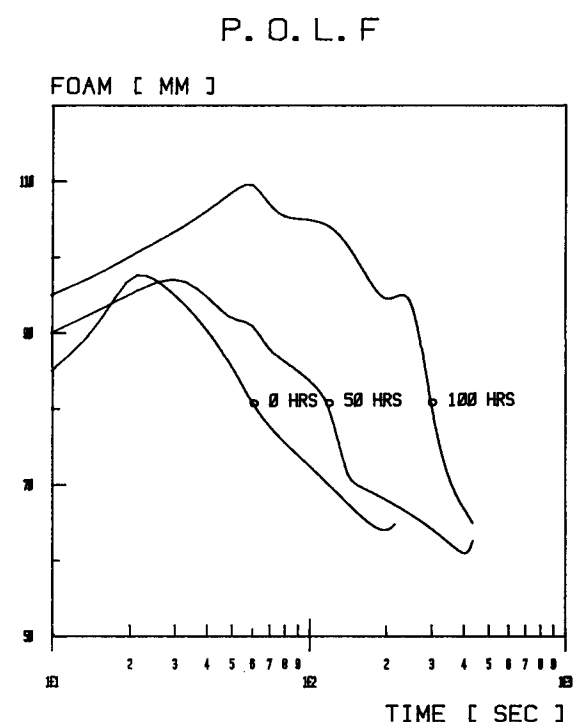
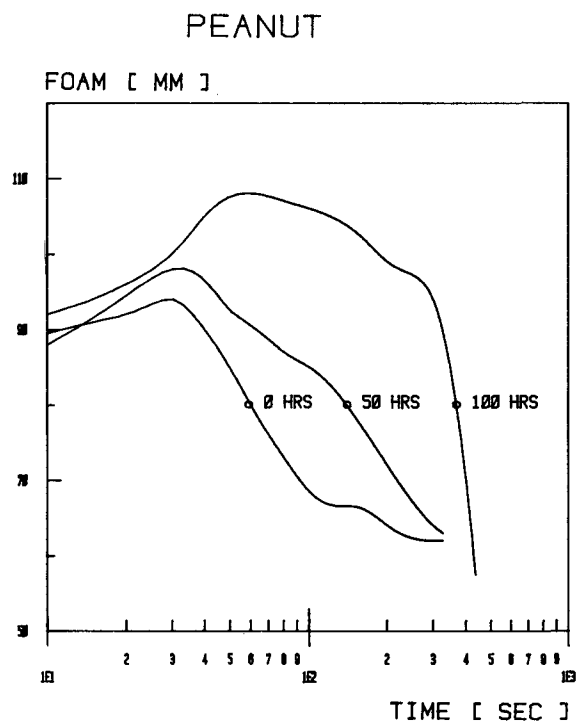

FIG. 4. Foam test diagrams.

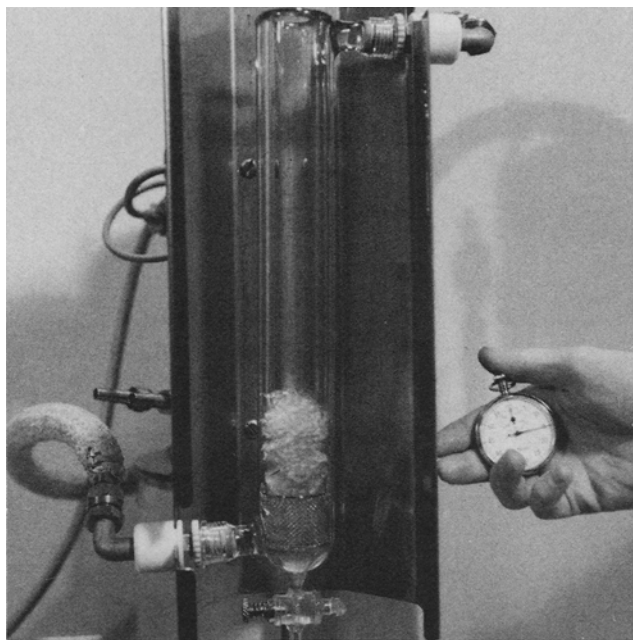

FIG. 5. Fresh oil foam test. Dipping time of the sample: 15 sec.

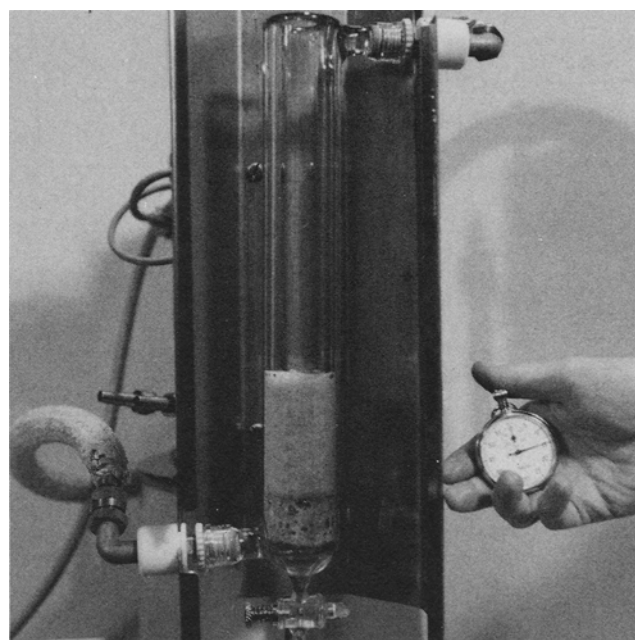

FIG. 6. Heat-abused oil foam test. Dipping time of sample: 15 sec.

the time necessary for oxygen-absorbing samples to reach -0.5 psi in a closed system, according to Astell (9); (d) foam test.

After prolonged heating, oils and fats show an increasing tendency to foam. Therefore, a foam index could provide information about the status of the oil: Khalil (10) recently described a method to evaluate foaming properties of the

oils by dropping bread, cottonwool and potatoes in oils from commercial fryers and giving some correlation between foaming properties and physical or chemical parameters. We developed a simple apparatus and method to judge the foaming tendency of oils and fats which basically consists of a double-shell glass column (id = 30 mm, length 40 mm), connected with Torion joint to a Lauda thermostat filled with silicone oil (smoke point, 230 C). A stainless-steel frying basket equipped with a perforated lid is introduced at the bottom of the column.

Fresh potatoes are cut to 6 × 6 × 6 mm cubes using the fried potato chipper, Zylis. The samples are then washed several times and stored in water at 5 C. Before using, the cubes are dried on a cotton towel. Figure 3 shows the complete apparatus (from right to left: chipper, glass column, thermostat and potato sample before the test).

About 35 g frying oil is poured into the double-shell column and heated to 180 C. After 10 min, the oil level is adjusted to 45 mm. The frying basket containing 5 g of potato cubes is dipped into the oil. Height of the foam is measured vs time.

The foam index (FI) is calculated as:

$$FI = \frac{T_2}{T_1}$$

TABLE II

Deep-Frying Oils: Characteristics

	POLF	Peanut
Slipmelting point (C)	<22	-2
Iodine value	60-70	80-85
FFA	< 0.1	< 0.1
SFI		
20 C	10	3
30 C	4	0
Lauric acid	0.3	0.1
Oleic acid	32-38	54-62
Linoleic acid	13-17	16-22
Linolenic acid	< 1	< 2
Saturated acids	34-40	16-19
Unsaponifiable	0.4	0.5

TABLE III

Peanut Oil Deterioration during Frying

Heated at 180 C; hr		FFA (%) as C18:1	Smoke point (C)	Flame point (C)	Viscosity cP at 25 C	Polymers (%)	Oxidized fatty acids (%)	Noneluted material NEM	FI ^a 2	C18:1 (%)	C18:2 (%)
corr.	exp.										
0	0	0.02	235	335	50	0.2	0.03	8	—	60.5	18.0
24	24	0.08	240	327	60	2.4	0.06	11	—	59.2	15.9
49	48	0.11	232	325	71	7.1	0.21	17	—	55.8	13.2
76	72	0.81	228	320	95	11.7	0.97	23	9.75	52.8	10.4
82	78	0.28	229	315	102	12.6	—	25	10.2	51.6	0.6
104	96	0.42	219	312	113	14.2	—	—	—	49.8	8.8

^aFI = foam index.

TABLE IV

POLF Deterioration during Frying

Heated at 180 C; hr		FFA (%) as C18:1	Smoke point (C)	Flame point (C)	Viscosity cP at 25 C	Polymers (%)	Oxidized fatty acids (%)	Noneluted material NEM	FJa ^a 2	C18:1 (%)	C18:2 (%)
corr.	exp.										
0	0	0.03	222	325	49	0.4	0	4	—	35.5	18
24	24	0.11	218	323	51	1.4	0.08	6	—	34.2	17.1
49	48	0.19	198	320	57	3.5	0.19	8	—	34.0	15.5
82	78	0.32	182	315	72	6.3	0.80	11	9.4	33.4	13.3
104	96	0.54	180	310	88	8.0	2.00	15	11.6	32.4	10.3
124	112	0.70	172	304	103	10.6	3.02	20	—	31.5	7.8

^aFJa = foam index.

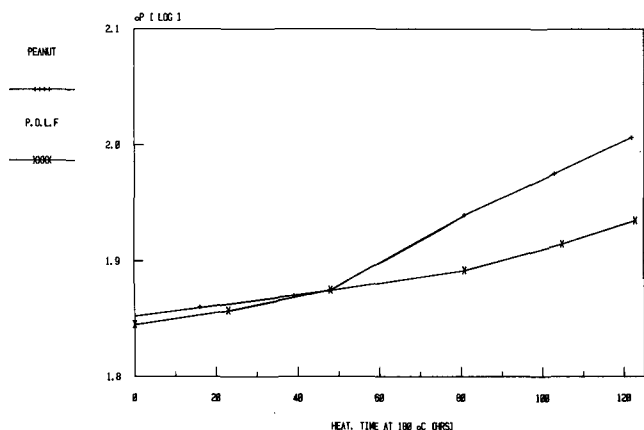

FIG. 7. Increase of viscosity during frying.

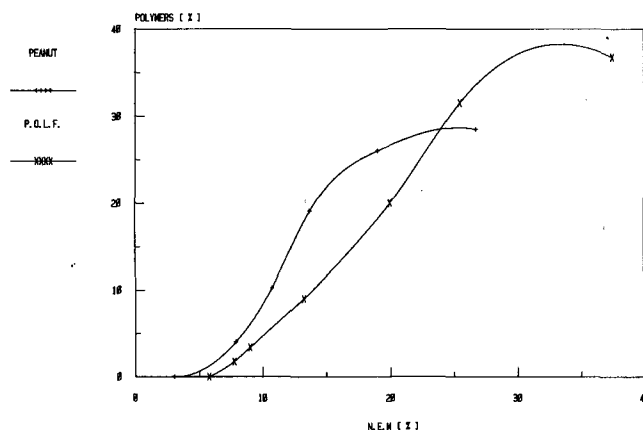

FIG. 8. Relationship between polymers and NEM.

where T_2 is the time necessary for the heat-abused frying oil foam to reach the 80 mm level, and T_1 is the time necessary for the fresh frying oil foam to reach the 80 mm level (Fig. 4).

Figures 5 and 6 show the foam test on fresh and heat-abused oil after 15 sec of dipping the potato sample.

RESULTS

The analytical data for POLF and peanut oil used as frying media in our trials are reported in Table II.

First Trials: Oil Specific Surface Increased during Frying

Tables III and IV show the analytical figures we checked during frying; the corrected time also is indicated to consider the increase in the oil specific surface resulting from continuous frying and sampling.

From these results, it can be stated that POLF performs at least as well as peanut oil in frying operations. Concerning the individual characteristics of the oils, it has been observed that a free fatty acid increase produces a straight line and follows an exponential law.

The viscosity curves are exponential-like, but, by plotting the logarithm of the viscosity against the heating time (Fig. 7), we can easily differentiate distinct areas defined by separated experimental curves. This reveals that an increase in viscosity is governed by at least 2 or more different kinetic processes, each showing individual increases in viscosity. Furthermore, these increases in viscosity are parallel to the individual stabilities of the oils investigated.

Polymers, noneluted material (NEM) and oxidized fatty acids show parallel values, indicating that the degree of

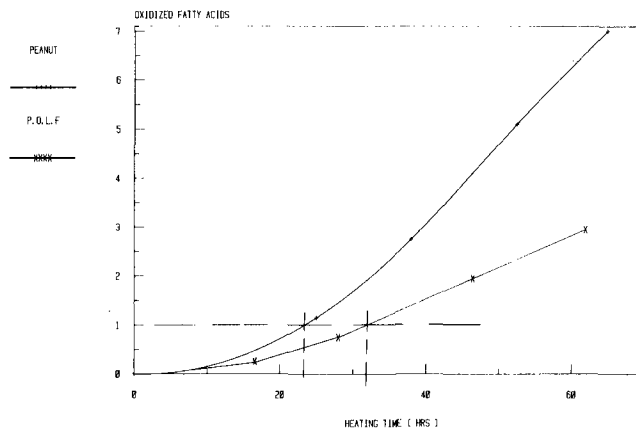

FIG. 9. Frying stability according to Pardun (1).

TABLE V

Relationship between Frying Stability and Specific Surface

Specific surface	Frying stability
(cm ² /g)	(hr)
0.63	17.5
0.58	18.0
0.28	18.9
0.23	18.5
0.20	19.5
0.13	29.0
0.10	37.0

TABLE VI

POLF: Analytical Data during Frying Process

	0 hr	50 hr	100 hr
FFA as oleic (%)	0.06	0.56	0.90
Smoke point (C)	228	198	182
Polymers (%)	0	7.5	12.2
$\frac{FIA^a}{2}$	2	4.7	12
Oil intake on 1100 g product (%)	15.5	16	16.4
Linoleic acid (%)	14.09	9.34	6.63
Loss in linoleic acid	0	4.75	7.46
NEM (%)	2.2	8.7	18.3
Induction period (hr) ^b	64	11	16

^aFI = foam index.

^bTime necessary for oxygen absorbing samples (4 g) to reach 0.5 psi in a closed system (9).

TABLE VII

Peanut Oil: Analytical Data during Frying Processes

	0 hr	50 hr	100 hr
FFA (%) as oleic	0.07	0.20	0.53
Smoke point (C)	233	206	196
Polymers (%)	0	6.4	10.8
$\frac{FIA^a}{2}$	2	4	10
Oil intake on 1100 g product (%)	15.7	18.2	19.9
Linoleic acid (%)	19.25	13.89	11.33
Loss in linoleic acid	0	5.36	7.92
NEM (%)	4.64	15.77	21.28
Induction period (hr) ^b	34	4	5

unsaturation of the fatty acid in the oils play an important role.

Moreover, according to the analytical procedures, NEM and polymers cover the same range of molecules as oxidized and polymerized triglycerides fatty acids, as well as unsaponifiable material. The correlation of NEM with polymers is shown in Figure 8.

Generally, NEM gives some positive figures, even when the amount of polymers is still negligible. When the amount of polymer has reached a certain level for most of the oils, the increase drops so that polymers attain a saturation level; NEM continues to increase.

Oxidized fatty acids also increase with heating time: the log of the percentage of oxidized fatty acids plotted against heating time shows straight lines for both POLF and peanut oil (Fig. 9). The frying stability defined according to

Pardun (1) as the time required for heating an oil at 180 C to reach 1% oxidized fatty acids is practically the same for all the oils investigated.

Trials with Constant Specific Oil Surface

As already mentioned, the main parameter influencing deep frying stability is the oil surface exposed to air: we calculated this correlation experimentally (Table V).

We then tried to keep the specific surface constant (Tables VI and VII).

It is interesting to point out the relationship we found between polymers calculated as the insoluble part after methanolysis and the foaming properties of the oil (calculated as already described). This relationship also has been observed for other kinds of oils and animal fats, as indi-

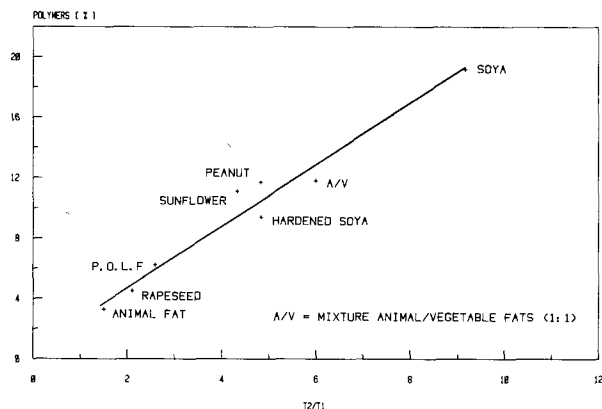

FIG. 10. Frying index and polymers after 72 hr.

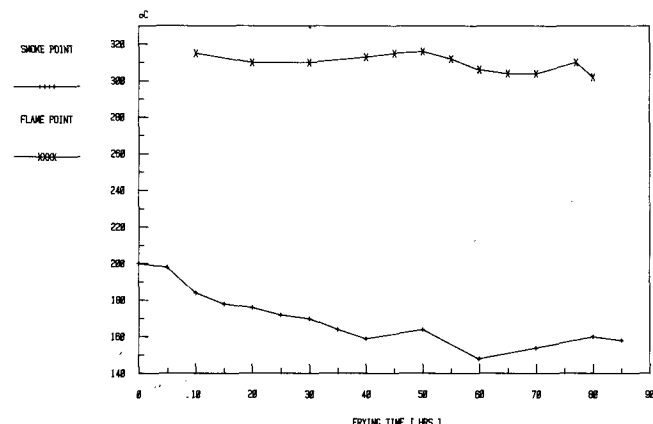

FIG. 11. Smoke and flame point vs frying time at 180 C/POLF.

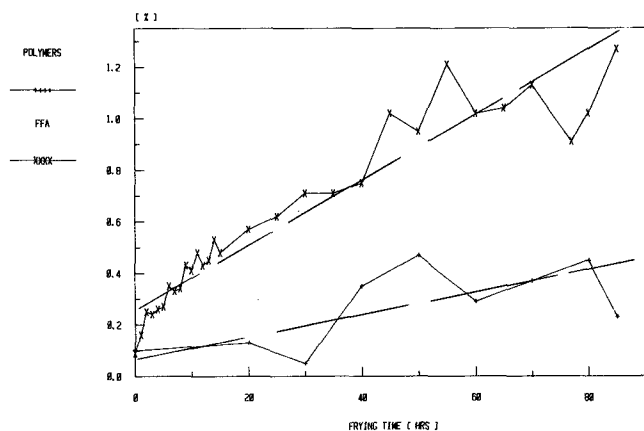

FIG. 12. Polymers and FFA vs frying time.

cated in Fig. 10, where we give the amount of polymer vs foam index for several oils after 72 hr of frying.

Industrial Trials

Finally, we obtained results during an industrial frying using POLF as frying medium at $180\text{ C} \pm 5\text{ C}$, at a capacity of 2,000 kg/hr. Smoke and flame point (Fig. 11), free fatty acids and polymer level (Fig. 12) have been determined during the frying operations.

Industrial operation results confirm the previous findings. We consider palm oil liquid fractions suitable oils for use in frying.

DISCUSSION

Frying fats were submitted to strong heating conditions under air in the presence of catalysts promoting oxidation,

polymerization and cracking. Moreover, fried foods, such as starchy and proteinaceous materials, enhance the degradation process and induce chemical changes in the oils, which negatively influence their physical properties.

The screening of frying oils requires specific analytical methods (i.e., polymer and noneluted material analysis, foam index, control of the oxyacid level) to follow the behavior in fryers and to determine the most suitable oils. We have described some of these methods and applied them in household and industrial fryers, specifically on palm oil liquid fractions and peanut oil (as control).

Results obtained indicated that POLF perform satisfactorily, show a lesser extent of degradation and produce fried foods with acceptable keeping qualities. This was also confirmed by the oxygen absorption after prolonged heating of the oils; induction periods generally are longer for POLF than for the peanut oil examined.

REFERENCES

1. Pardun, H., J. Blass and E. Kroll, *Fette Seifen Anstrichm.* 76:97 (1974).
2. Pardun, H., J. Blass and E. Kroll, *Ibid.* 76:151 (1974).
3. *Swiss Manual for Food Analysis, Part 2*, edited by Eidgenossische Drucksachen u. Materialzentrale Bern, Switzerland, chapt. 7, method 9, 1969.
4. *Deutsche Gesellschaft für Fettwissenschaft*, edited by Wissenschaftliche Verlagsgesellschaft mbH, Stuttgart, W. Germany, method C-14 (9), 1953.
5. *Ibid.* Method C-III (3), 1953.
6. Masson, M.E., *Anal. Chem.* 36:583 (1964).
7. Walting, A.E., *JAOCS* 52:96 (1975).
8. Peled, M., T. Gutfinger and A. Letan, *J. Sci. Food Agric.* 26:1661 (1975).
9. British Food Manufacturing Industries Research Assn., Leatherhead, Surrey, UK, Technical Circular 654, May 1978.
10. Khalil, S.A., in *British Food Manufacturing Industries Research Assn. Research Report* 314, 1979.

[Received May 1, 1980]